

A SINGLE PORT DATA OUTLET

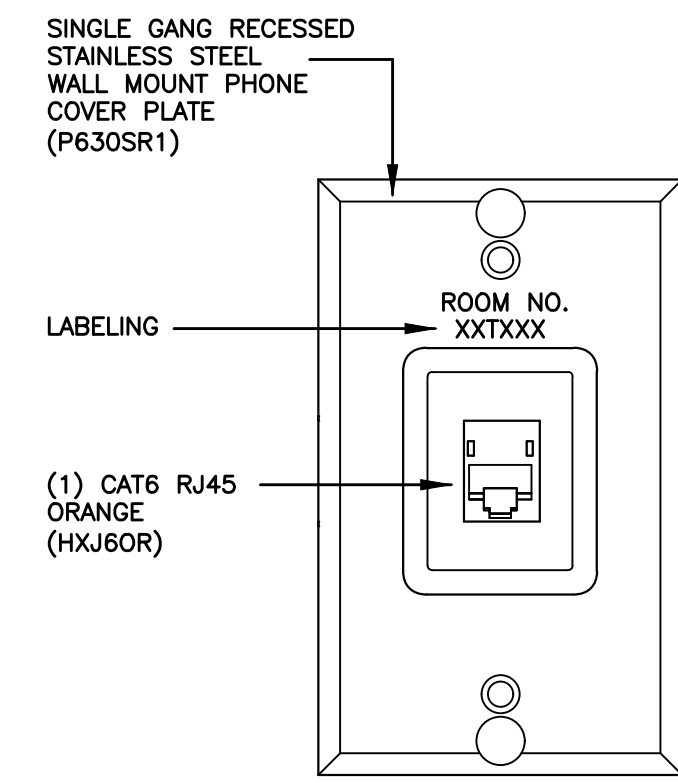

B WALL MOUNTED PHONE/TELE OUTLET

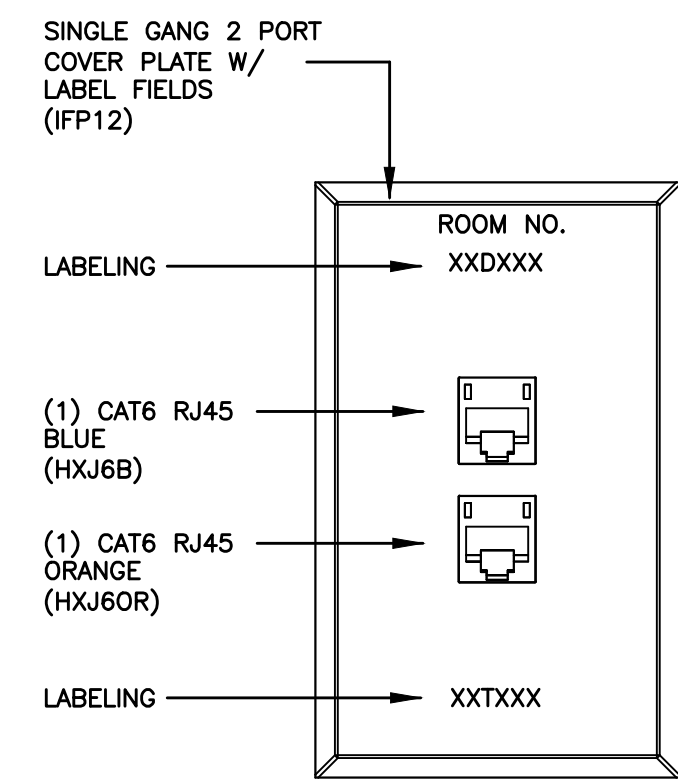

C DUAL PORT DATA/TELE OUTLET

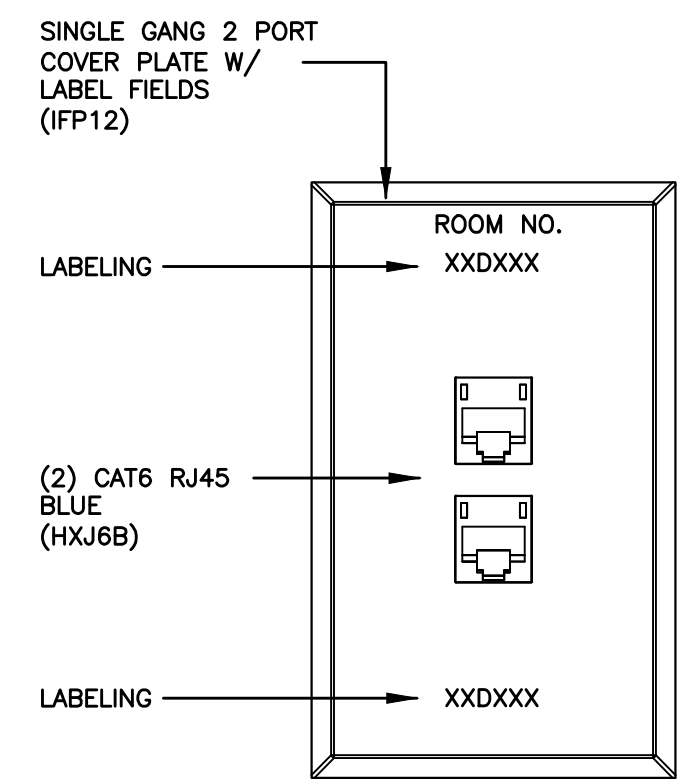

D DUAL PORT DATA OUTLET

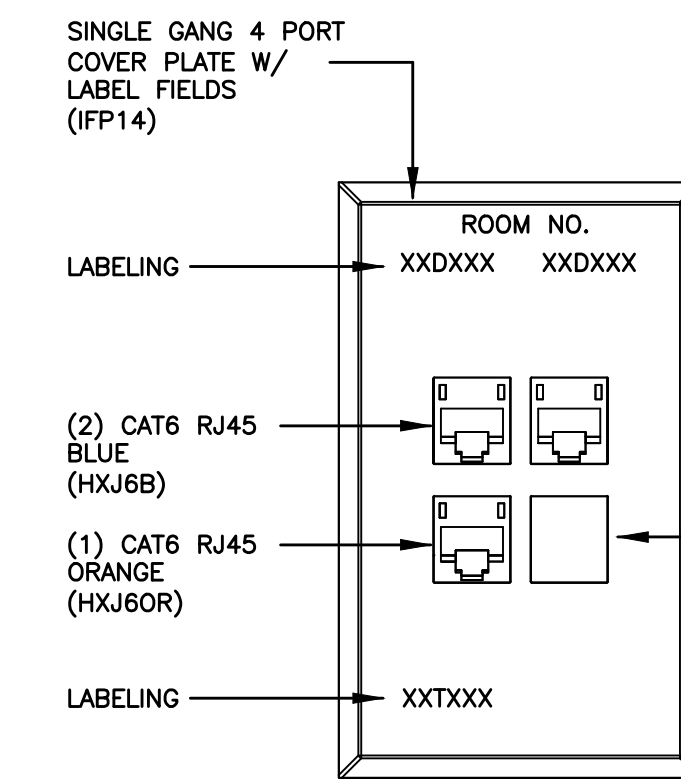

E TRIPLE PORT DATA/TELE OUTLET

GENERAL NOTES:
 1. COORDINATE FACEPLATE, PLASTIC INSERT, AND CONNECTOR HOUSING COLORS WITH ARCHITECT/ENGINEER PRIOR TO ORDERING.
 2. HUBBELL PART NUMBERS ARE SHOWN IN PARENTHESIS. EQUALS BY LEVITON AND P&S.
 3. RJ45 CONNECTORS SHALL MATCH COLOR OF ASSOCIATED CABLE. REFER TO CABLE COLOR CODE.

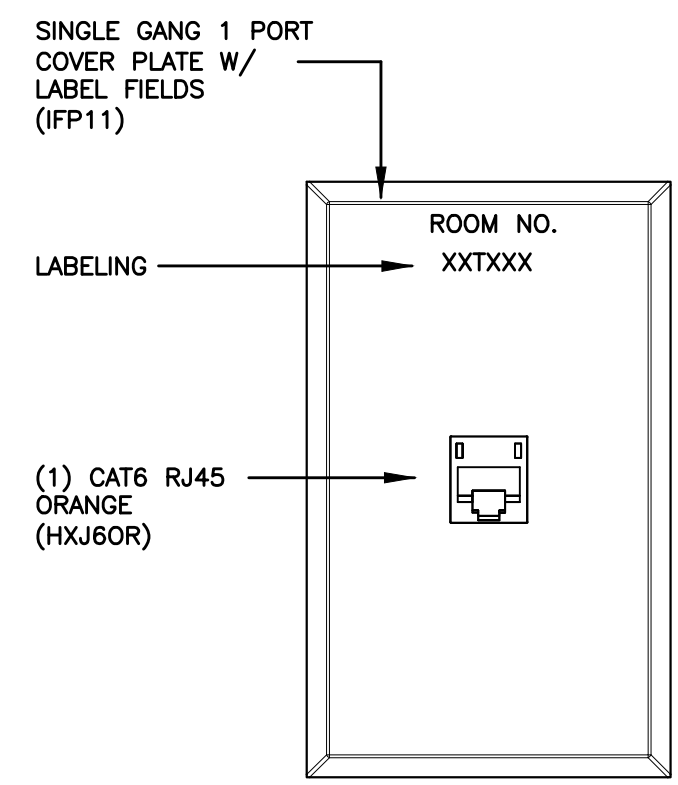

F SINGLE PORT TELE OUTLET

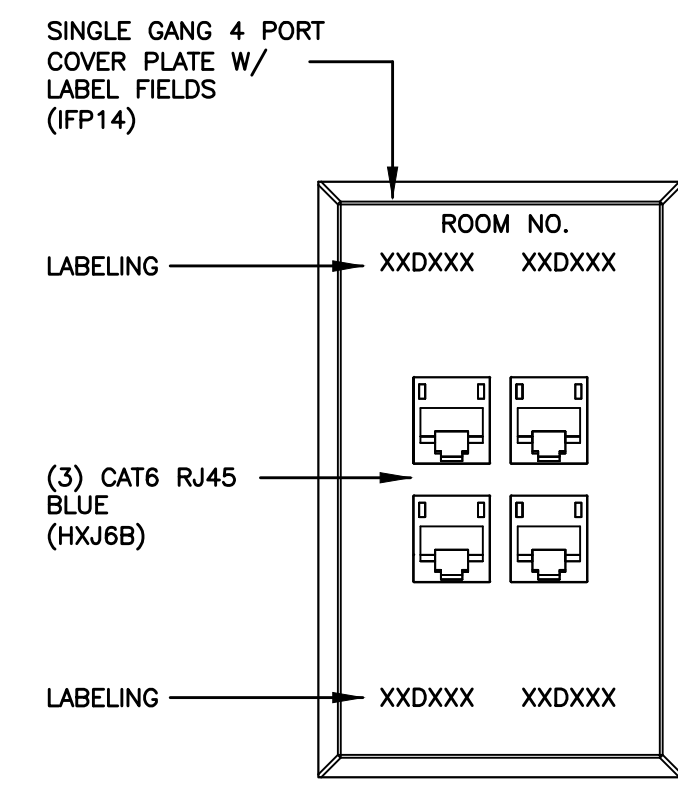

G QUAD PORT DATA OUTLET

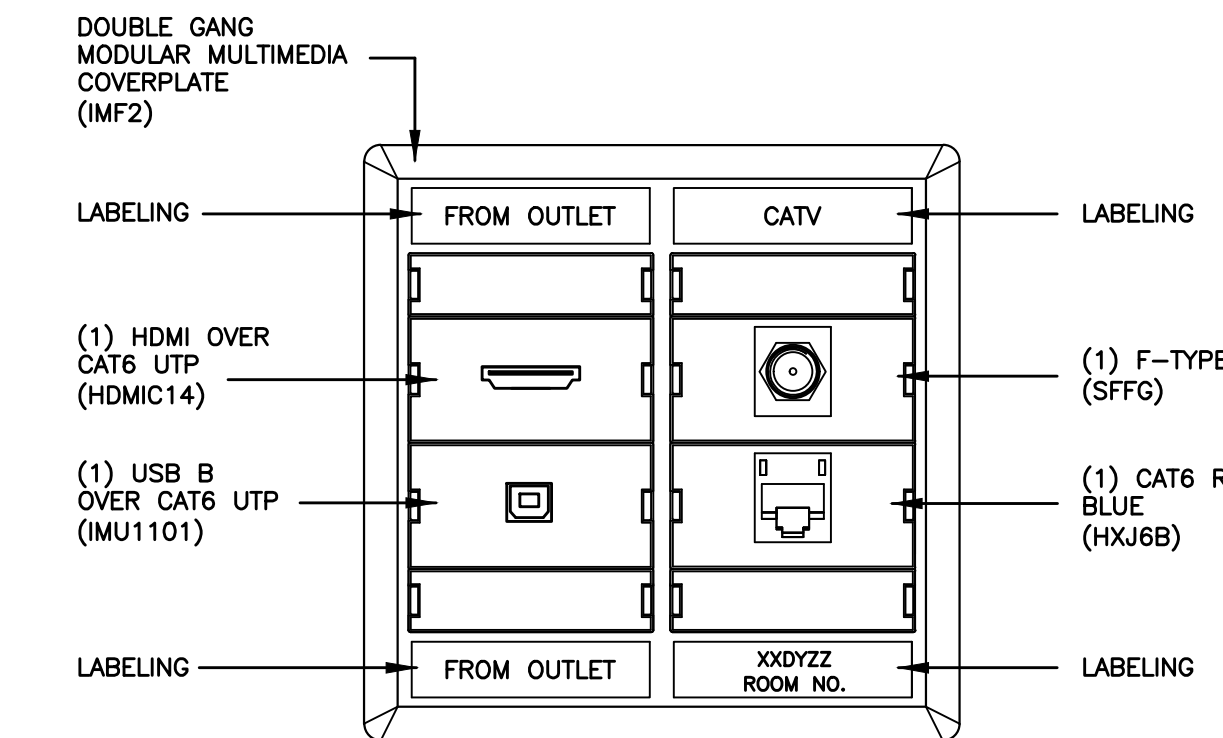

H TELEVISION VIDEO DISPLAY OUTLET

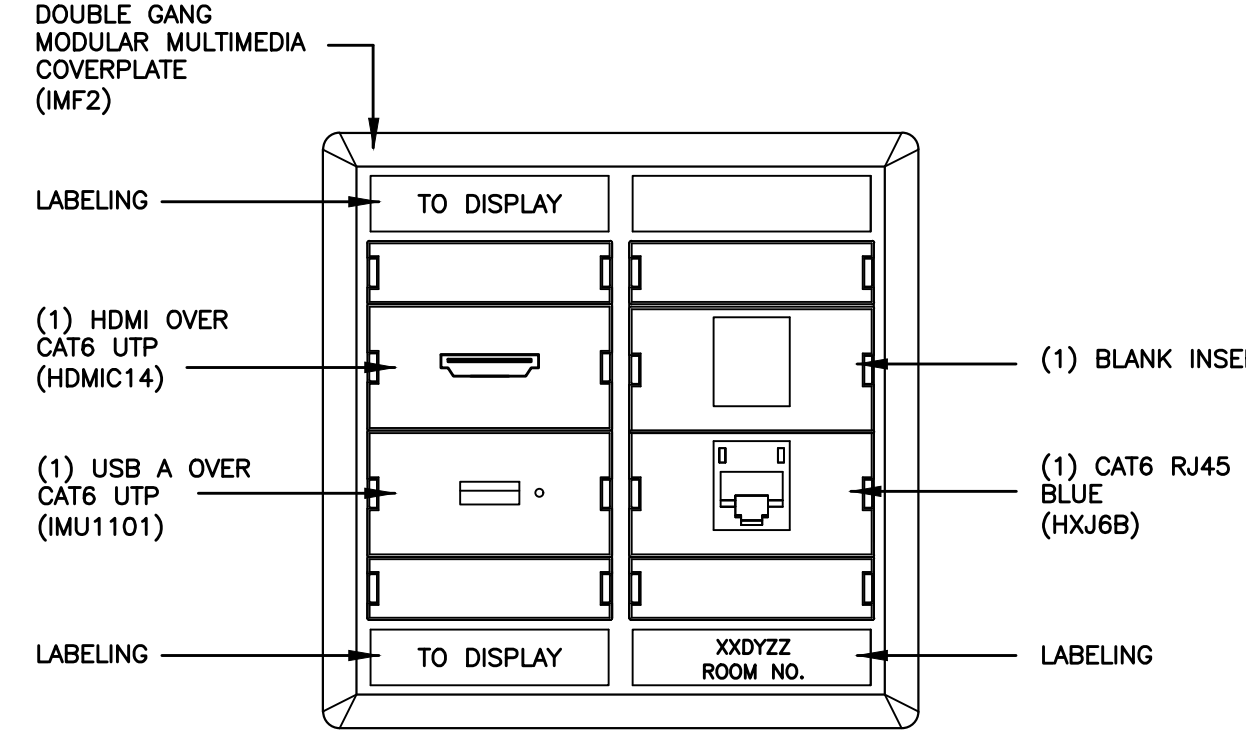

I MULTIMEDIA OUTLET

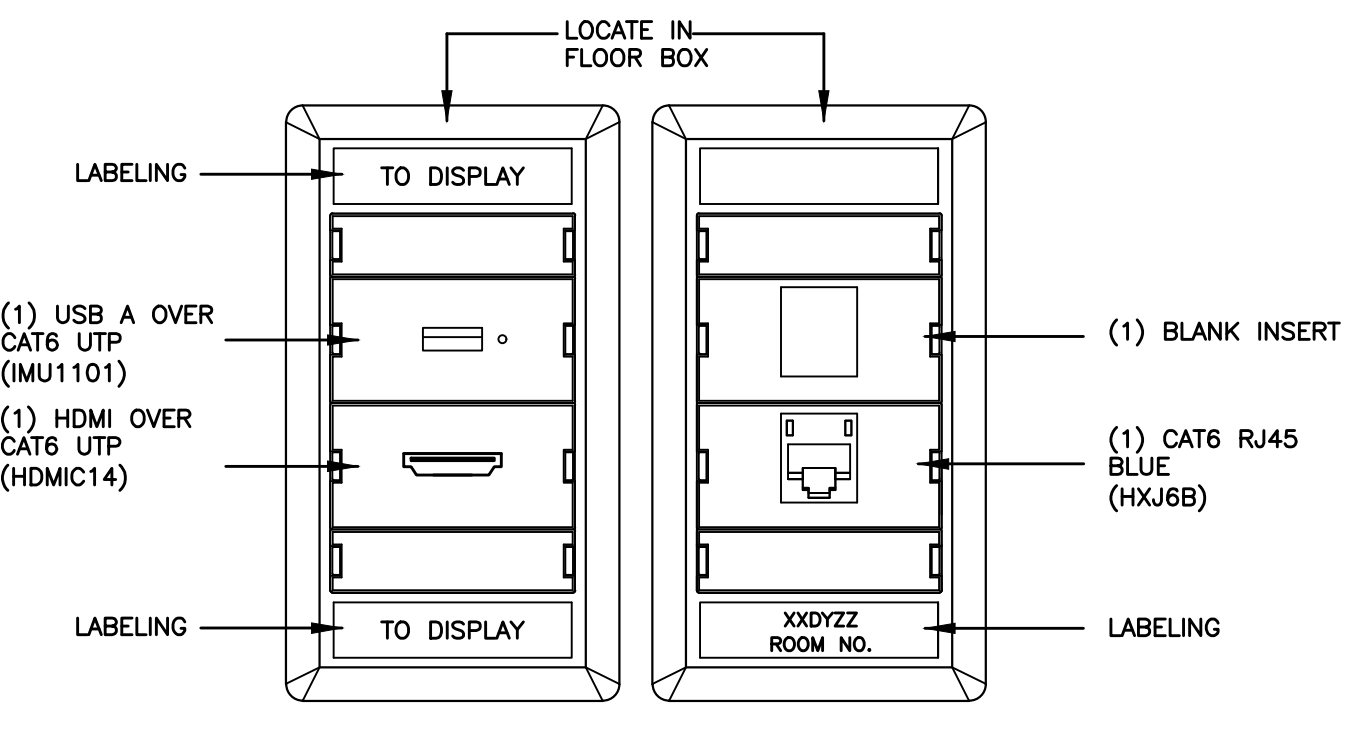

J MULTIMEDIA OUTLET

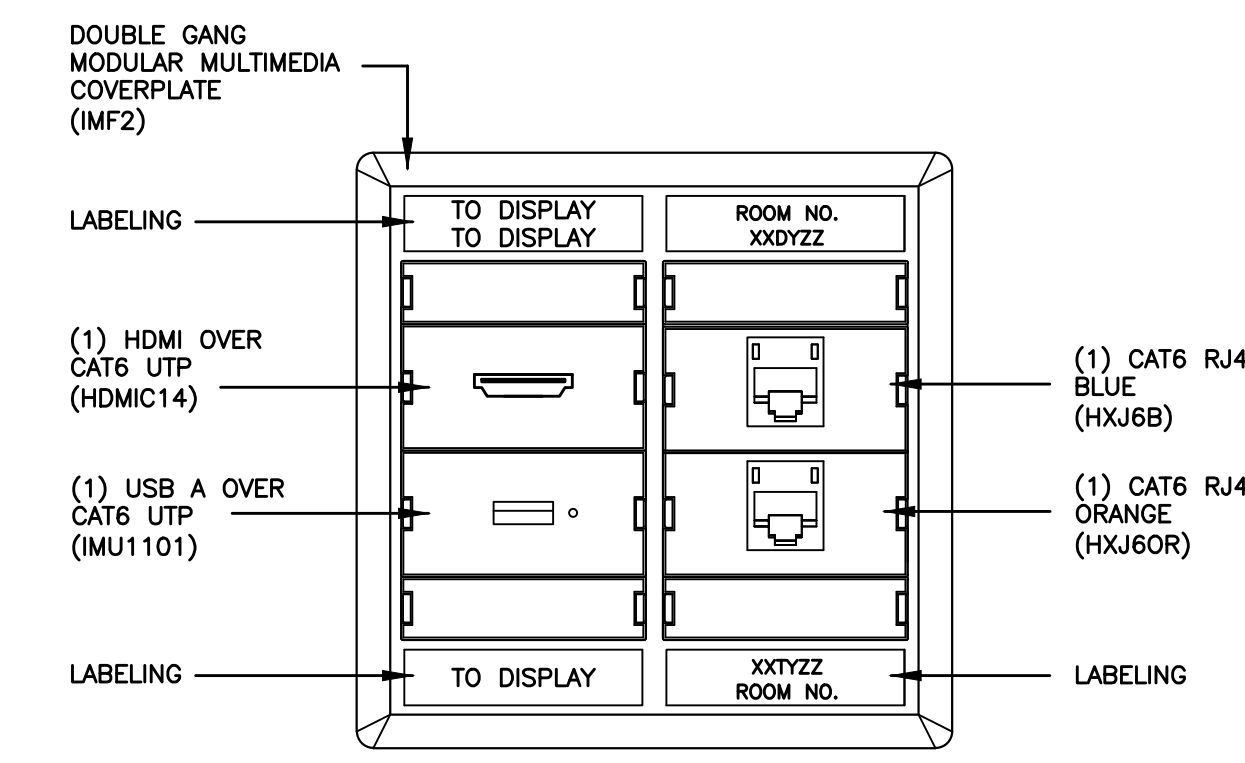

K MULTIMEDIA OUTLET

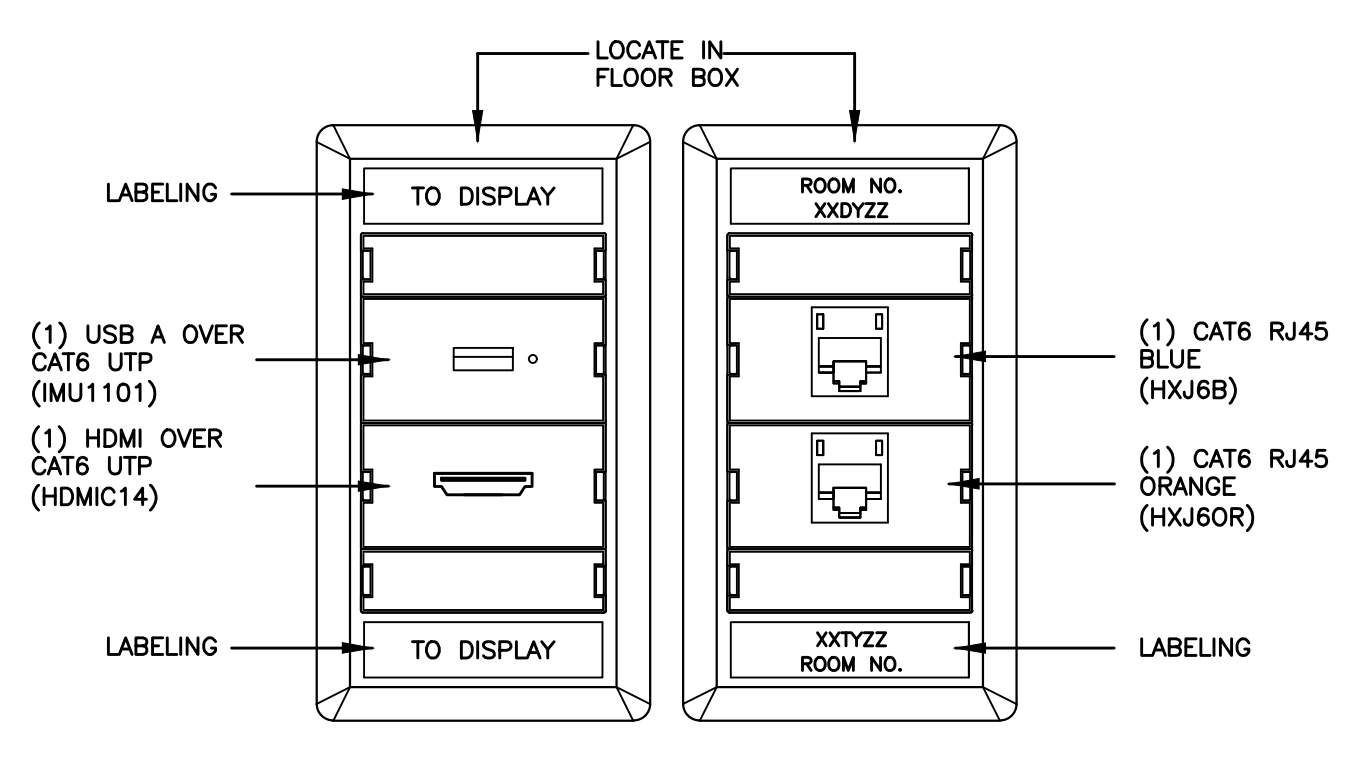

L MULTIMEDIA OUTLET

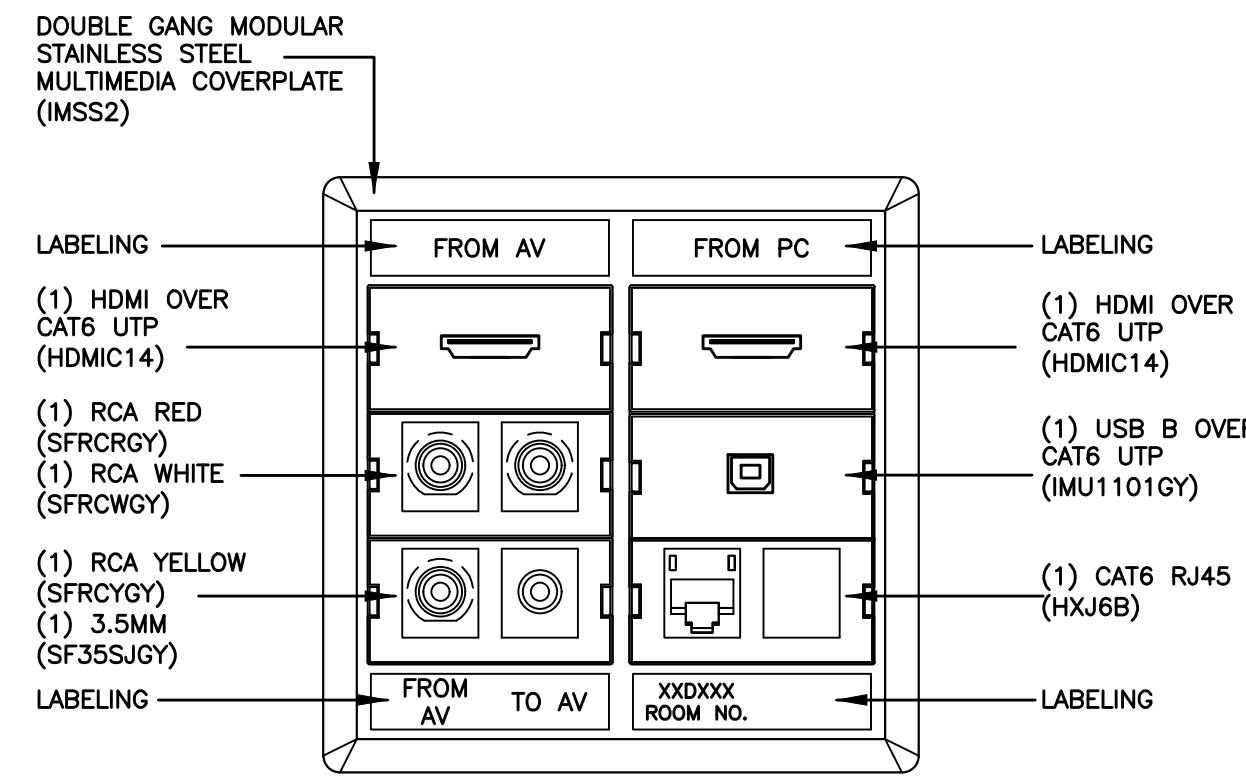

M BOARDROOM VIDEO DISPLAY OUTLET

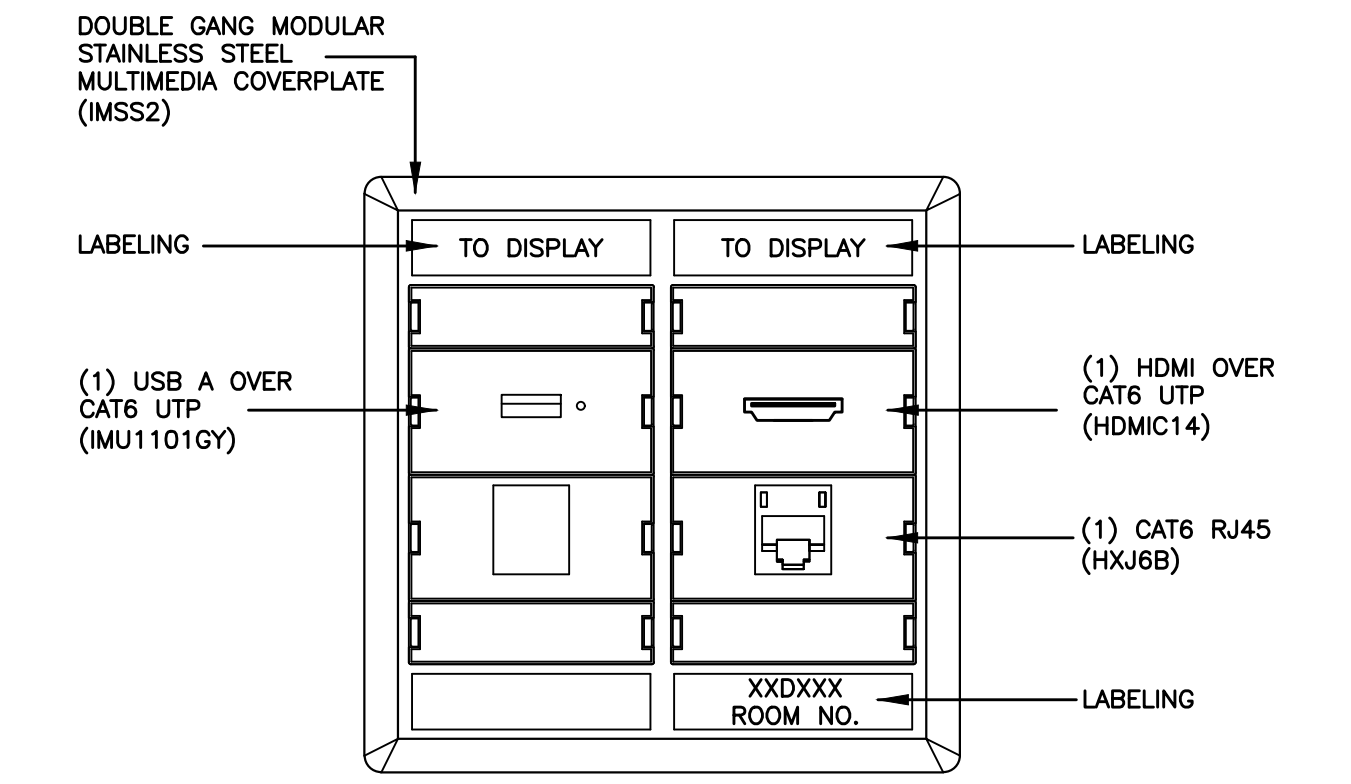

N BOARDROOM MULTIMEDIA OUTLET

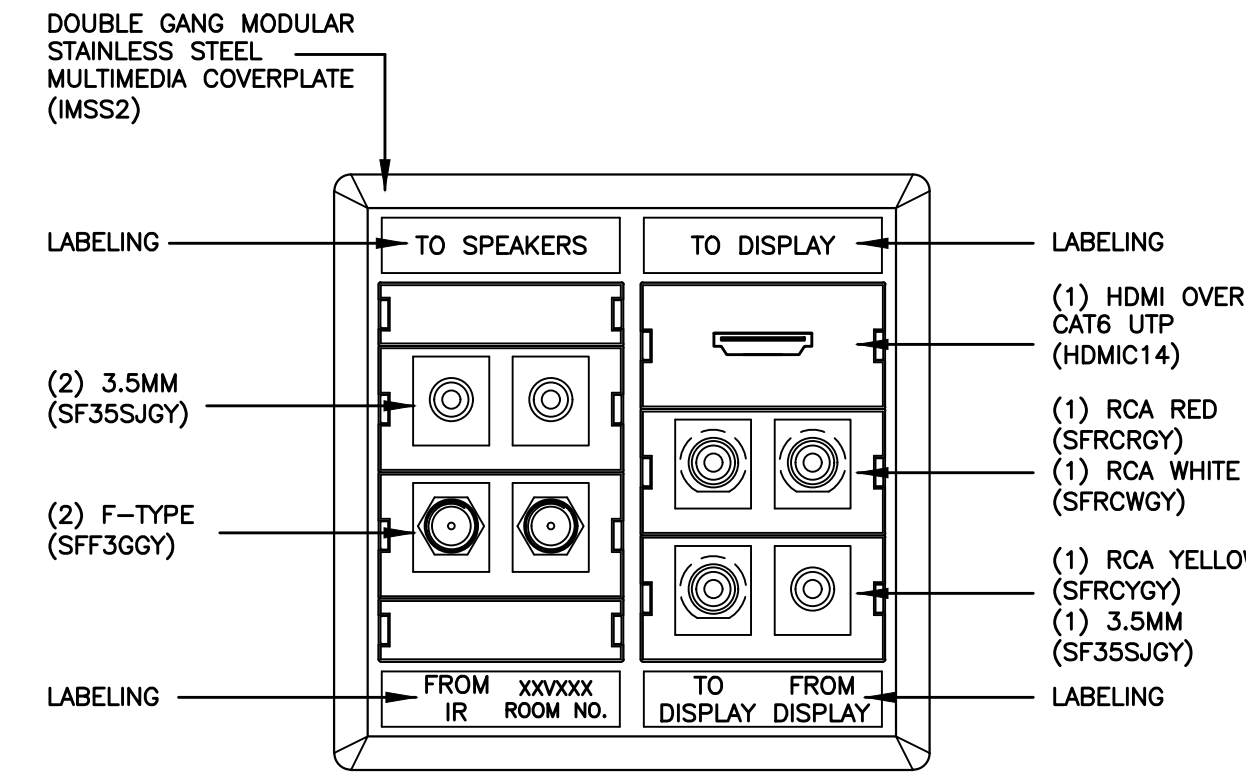

O BOARDROOM AUDIO/VIDEO CABINET MULTIMEDIA OUTLET

REVISION
1

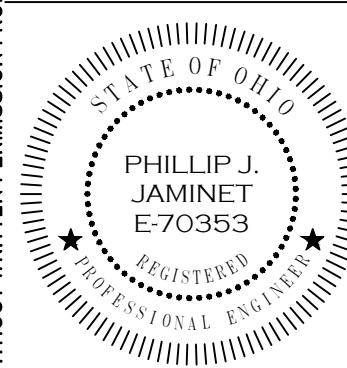

114 EAST FRONT STREET
 YOUNGSTOWN, OHIO
 (330) 744-8981

OLSAVSKY JAMINET • ARCHITECTS
 OHIO UTILITIES PROTECTION SERVICE - NEW OFFICE BUILDING
 12467 MAHONING AVENUE
 NORTH JACKSON, OHIO 44451

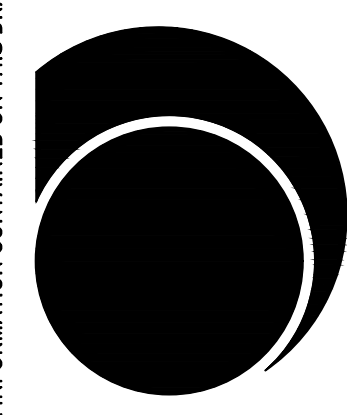

PROJECT NO. 15-008
 ISSUED 9-6-16
 DRAWN SS/AMJP

E15

PHILLIP J. JAMINET ENGINEERING
 29 E. FRONT STREET
 YOUNGSTOWN, OHIO 44503
 T: 330.747.1999
 F: 330.747.3535
 WWW.PJJEENGINEERING.COM
 JOB NO. 051.015